

# NBC-MS/ 5,0-94B/R4AC SCO - Network cable



1407416

<https://www.phoenixcontact.com/in/products/1407416>

Please be informed that the data shown in this PDF document is generated from our online catalog. Please find the complete data in the user documentation. Our general terms of use for downloads are valid.

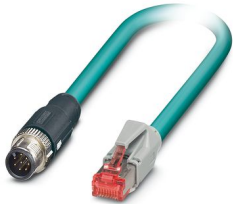

Network cable, Ethernet CAT5 (1 Gbps), 8-position, shielded, Plug straight M12 SPEEDCON, coding: A / IP67, on Plug straight RJ45 / IP20, cable length: 5 m

## Commercial data

Item number	1407416
Packing unit	1 pc
Minimum order quantity	1 pc
Sales key	BF1
Product key	BF1CMI
Catalog page	Page 401 (C-2-2019)
GTIN	4046356775380
Weight per piece (including packing)	266.6 g
Weight per piece (excluding packing)	262.7 g
Customs tariff number	85444210
Country of origin	PL

1407416

<https://www.phoenixcontact.com/in/products/1407416>

## Technical data

### Notes

General	Further products with variable cable type and variable cable length can be found in the accessories section
---------	---

### Product properties

Product type	Data cable preassembled
Sensor type	Ethernet
Number of positions	8
Application	Standard
Shielded	yes
Coding	A

### Interfaces

Bus system	Ethernet
Signal type/category	Ethernet CAT5 (based on IEC 11801), 1 Gbps

### Signaling

Status display	No
Status display present	No

### Electrical properties

Nominal voltage $U_N$	30 V AC
	30 V DC
Nominal current $I_N$	1 A
Transmission medium	Copper
Transmission characteristics (category)	CAT5 (IEC 11801:2002)

### Connector

#### Connection 1

Type	Plug straight M12 SPEEDCON / IP67
Number of positions	8
Locking type	SPEEDCON
Coding type	A (Standard)
Material	CuZn (Contact)
	Ni/Au (Contact surface)
	TPU GF (Contact carriers)
	TPU, hardly inflammable, self-extinguishing (Grip)
	Zinc die-cast, nickel-plated (Screw connection)
Insertion/withdrawal cycles	$\geq 100$
Contact resistance	$\leq 5 \text{ m}\Omega$
Insulation resistance	$\geq 100 \text{ M}\Omega$
Tightening torque	0.4 Nm

# NBC-MS/ 5,0-94B/R4AC SCO - Network cable



1407416

<https://www.phoenixcontact.com/in/products/1407416>

Degree of protection	IP67
Ambient temperature (operation)	-25 °C ... 90 °C

## Connection 2

Type	Plug straight RJ45 / IP20
Number of positions	8 (8)
Handle color	gray
Material	CuSn (Contact)
	Ni/Au (Contact surface)
	PC (Contact carriers)
	PA (Housing)
Insertion/withdrawal cycles	≥ 750
Degree of protection	IP20
Ambient temperature (operation)	-25 °C ... 60 °C

## Cable/line

Cable length	5 m
--------------	-----

## Ethernet flexible CAT5, 4-pair [94B]

Dimensional drawing	
Cable weight	47 kg/km
UL AWM Style	20963 (80°C/30 V)
Number of positions	8
Shielded	yes
Cable type	Ethernet flexible CAT5, 4-pair [94B]
Conductor structure	4x2xAWG26/7, SF/UTP
Signal runtime	5.3 ns/m
Conductor structure signal line	7x 0.16 mm
AWG signal line	26
Conductor cross section	4x 2x 0.14 mm <sup>2</sup>
Wire diameter incl. insulation	0.96 mm
External cable diameter	6.4 mm ±0.2 mm
Outer sheath, material	PUR
External sheath, color	water blue RAL 5021
Conductor material	Bare Cu litz wires
Material wire insulation	Foamed PE
Single wire, color	white/blue-blue, white/orange-orange, white/green-green, white/brown-brown

# NBC-MS/ 5,0-94B/R4AC SCO - Network cable



1407416

<https://www.phoenixcontact.com/in/products/1407416>

Thickness, outer sheath	1.05 mm
Twisted pairs	2 cores to the pair
Overall twist	4 pairs for core
Optical shield covering	70 %
Insulation resistance	$\geq 5 \text{ G}\Omega \cdot \text{km}$
Coupling resistance	$\leq 100.00 \text{ m}\Omega/\text{m}$ (at 10 MHz)
Loop resistance	$\leq 290.00 \text{ }\Omega/\text{km}$
Wave impedance	$100 \text{ }\Omega \pm 5 \text{ }\Omega$ (at 100 MHz)
Cable capacity	48 nF/km (at 1 kHz)
Nominal voltage, cable	$\leq 100 \text{ V}$
Test voltage Core/Core	700 V (50 Hz, 1 min.)
Test voltage Core/Shield	700 V (50 Hz, 1 min.)
Minimum bending radius, fixed installation	4 x D
Minimum bending radius, flexible installation	8 x D
Smallest bending radius, fixed installation	26 mm
Smallest bending radius, movable installation	52 mm
Tensile strength	$\leq 100 \text{ N}$
Near end crosstalk attenuation (NEXT)	71.3 dB (with 1 MHz)
	62.3 dB (at 4 MHz)
	56.3 dB (at 10 MHz)
	53.2 dB (at 16 MHz)
	51.8 dB (at 20 MHz)
	48.9 dB (at 31.25 MHz)
	44.4 dB (at 62.5 MHz)
	41.3 dB (at 100 MHz)
Power-summed near end crosstalk attenuation (PSNEXT)	62.3 dB (with 1 MHz)
	53.3 dB (at 4 MHz)
	47.3 dB (at 10 MHz)
	44.2 dB (at 16 MHz)
	42.8 dB (at 20 MHz)
	39.9 dB (at 31.25 MHz)
	35.4 dB (at 62.5 MHz)
	32.3 dB (at 100 MHz)
Return attenuation (RL)	23 dB (at 4 MHz)
	24.1 dB (at 8 MHz)
	25 dB (at 10 MHz)
	25 dB (at 16 MHz)
	25 dB (at 20 MHz)
	23.6 dB (at 31.25 MHz)
	21.5 dB (at 62.5 MHz)
	20.1 dB (at 100 MHz)
Shield attenuation	3.2 dB (with 1 MHz)
	6 dB (at 4 MHz)
	9.5 dB (at 10 MHz)

1407416

<https://www.phoenixcontact.com/in/products/1407416>

	12.1 dB (at 16 MHz)
	13.6 dB (at 20 MHz)
	17.1 dB (at 31.25 MHz)
	24.8 dB (at 62.5 MHz)
	32 dB (at 100 MHz)
Halogen-free	according to IEC 60754-1
Flame resistance	according to IEC 60332-1-2
Resistance to oil	in accordance with EN 60811-2-1
Ambient temperature (operation)	-40 °C ... 80 °C (cable, fixed installation)
	-20 °C ... 80 °C (Cable, flexible installation)
Ambient temperature (installation)	-20 °C ... 80 °C

### Environmental and real-life conditions

#### Ambient conditions

Degree of protection	IP65 (M12 connector)
	IP67 (M12 connector)
	IP20 (RJ45 connector)
Ambient temperature (operation)	-25 °C ... 90 °C (M12 connector)
	-20 °C ... 70 °C (RJ45 connector)

### Standards and regulations

#### M12

Standard designation	M12 connector
Standards/specifications	IEC 61076-2-101

Drawings

Circuit diagram

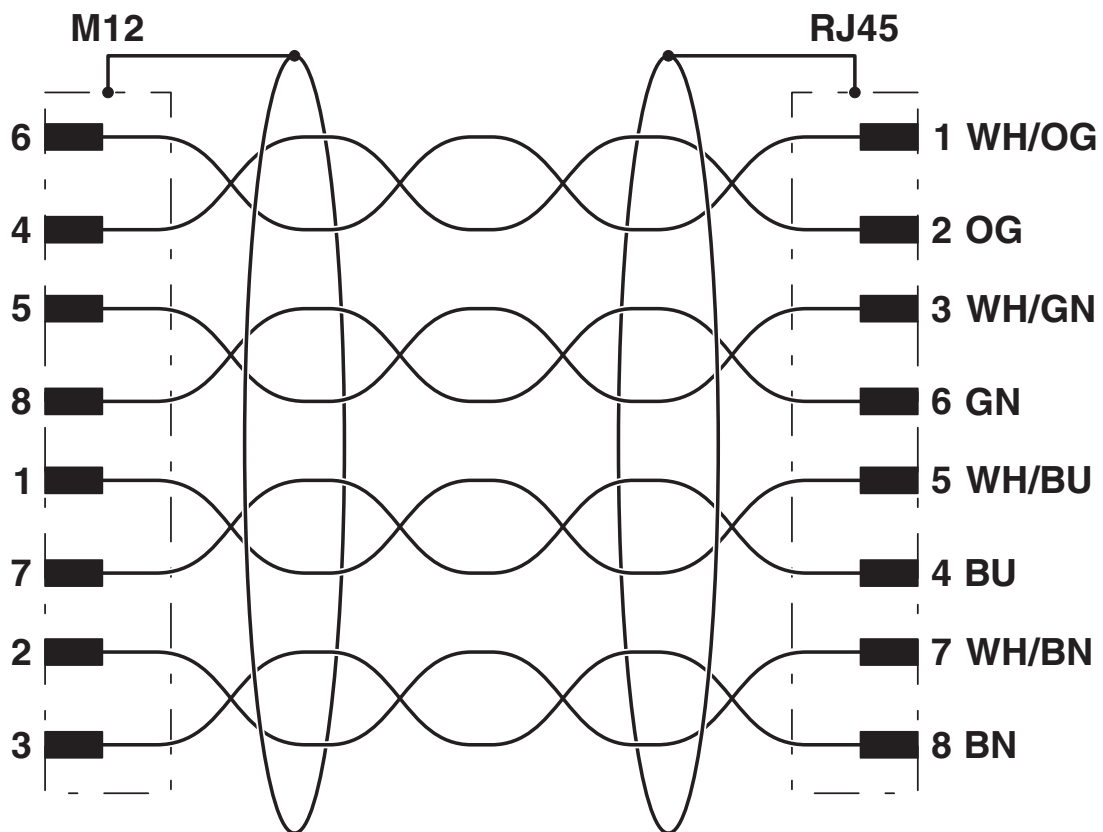

Schematic diagram



Connector pin assignment plug RJ45

# NBC-MS/ 5,0-94B/R4AC SCO - Network cable



1407416

<https://www.phoenixcontact.com/in/products/1407416>

Dimensional drawing

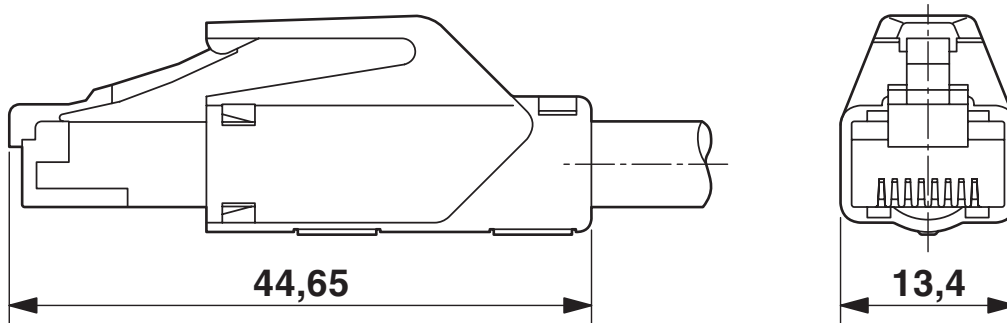

RJ45 connector, IP20

Dimensional drawing

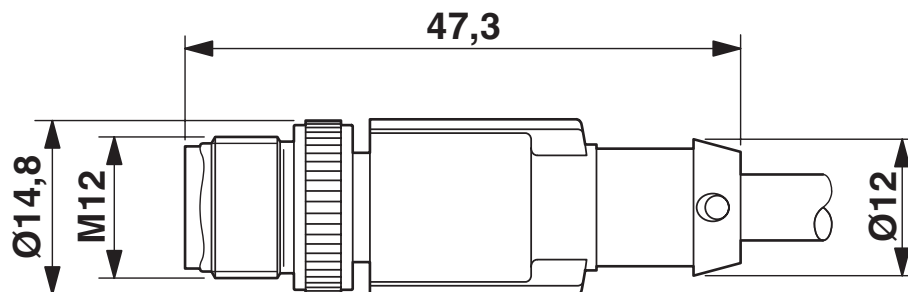

Plug, M12 x 1, straight, shielded

1407416

<https://www.phoenixcontact.com/in/products/1407416>

Schematic diagram

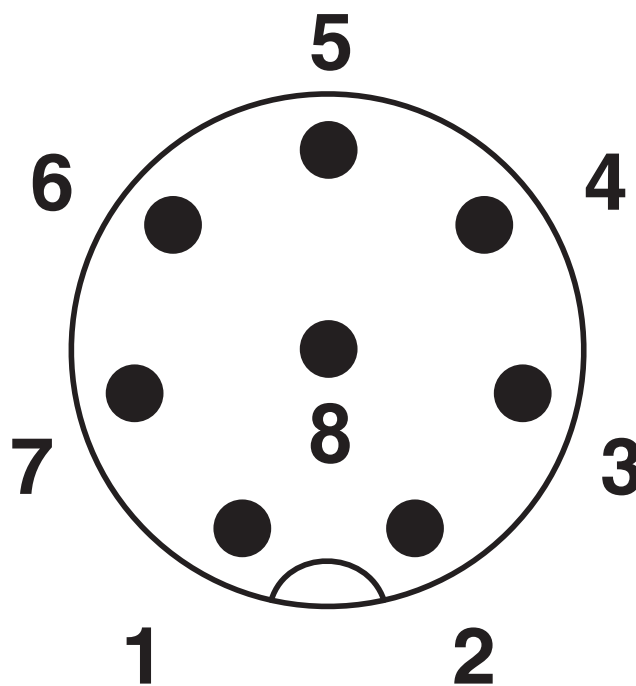

Pin assignment M12 plug, 8-pos., A-coded, view plug side

1407416

<https://www.phoenixcontact.com/in/products/1407416>

## Approvals

To download certificates, visit the product detail page: <https://www.phoenixcontact.com/in/products/1407416>

 <b>UL Listed</b> Approval ID: FILE E 335024				
	Nominal voltage $U_N$	Nominal current $I_N$	Cross section AWG	Cross section $mm^2$
	30 V	0.5 A	-	-

 <b>cUL Listed</b> Approval ID: FILE E 335024				
	Nominal voltage $U_N$	Nominal current $I_N$	Cross section AWG	Cross section $mm^2$
	30 V	0.5 A	-	-

 <b>EAC-RoHS</b> Approval ID: RU D-DE.HB35.B.00387	
---	--

<b>cULus Listed</b>	
---------------------	--

# NBC-MS/ 5,0-94B/R4AC SCO - Network cable



1407416

<https://www.phoenixcontact.com/in/products/1407416>

## Classifications

### ECLASS

ECLASS-11.0	27060307
ECLASS-12.0	27060307
ECLASS-13.0	27060307

### ETIM

ETIM 9.0	EC001855
----------	----------

### UNSPSC

UNSPSC 21.0	26121600
-------------	----------

# NBC-MS/ 5,0-94B/R4AC SCO - Network cable



1407416

<https://www.phoenixcontact.com/in/products/1407416>

## Environmental product compliance

China RoHS	Environmentally friendly use period: unlimited = EFUP-e
	No hazardous substances above threshold values

# NBC-MS/ 5,0-94B/R4AC SCO - Network cable



1407416

<https://www.phoenixcontact.com/in/products/1407416>

## Accessories

### NBC-MS-R4AC SCO-IE/.../... - Network cable

1408681

<https://www.phoenixcontact.com/in/products/1408681>



Network cable, Ethernet CAT5 (1 Gbps), 8-position, Variable cable type, shielded, Plug straight M12 SPEEDCON, coding: A / IP67, on Plug straight RJ45 / IP20, cable length: Free input (0.2 ... 40.0 m)

### NBC-MR-R4AC SCO-IE/.../... - Network cable

1408674

<https://www.phoenixcontact.com/in/products/1408674>



Network cable, Ethernet CAT5 (1 Gbps), 8-position, Variable cable type, shielded, Plug angled M12 SPEEDCON, coding: A / IP67, on Plug straight RJ45 / IP20, cable length: Free input (0.2 ... 40.0 m)

## NBC-MS/ 5,0-94B/R4AC SCO - Network cable

1407416

<https://www.phoenixcontact.com/in/products/1407416>



## NBC-FS-R4AC SCO-IE/.../... - Network cable

1408664

<https://www.phoenixcontact.com/in/products/1408664>



Network cable, Ethernet CAT5 (1 Gbps), 8-position, Variable cable type, shielded, Socket straight M12 SPEEDCON, coding: A / IP67, on Plug straight RJ45 / IP20, cable length: Free input (0.2 ... 40.0 m)

---

## NBC-FR-R4AC SCO-IE/.../... - Network cable

1408655

<https://www.phoenixcontact.com/in/products/1408655>



Network cable, Ethernet CAT5 (1 Gbps), 8-position, Variable cable type, shielded, Socket angled M12 SPEEDCON, coding: A / IP67, on Plug straight RJ45 / IP20, cable length: Free input (0.2 ... 40.0 m)

# NBC-MS/ 5,0-94B/R4AC SCO - Network cable



1407416

<https://www.phoenixcontact.com/in/products/1407416>

## PROT-M12 FS-PA-CHAIN - Sealing cap

1430873

<https://www.phoenixcontact.com/in/products/1430873>

M12 sealing cap made of plastic with fixing band, for sensor cables, for free M12 plugs



---

## SAC-M12-EXCLIP-M - Locking clip

1558988

<https://www.phoenixcontact.com/in/products/1558988>

Locking clip for the pin side of sensor/actuator cables with M12 connector and M12 connectors for assembly, for knurl diameter: 15 mm or for Allen key with a wrench size of 14 mm, prevents the disconnection of plug-in connections without tools



# NBC-MS/ 5,0-94B/R4AC SCO - Network cable



1407416

<https://www.phoenixcontact.com/in/products/1407416>

## TSD 04 SAC - Torque screwdriver

1208429

<https://www.phoenixcontact.com/in/products/1208429>



Torque screwdriver, with preset torque of 0.4 Nm and 4 mm hexagonal drive for M12 connectors

---

## TSD-M 1,2NM - Torque screwdriver

1212224

<https://www.phoenixcontact.com/in/products/1212224>



Torque screw driver, accuracy as per EN ISO 6789 standard, adjustable from 0.3 - 1.2 Nm

# NBC-MS/ 5,0-94B/R4AC SCO - Network cable



1407416

<https://www.phoenixcontact.com/in/products/1407416>

## TSD-M SAC-BIT ADAPTER - Adapter insert

1212600

<https://www.phoenixcontact.com/in/products/1212600>



Adapter bit for TSD-M...torque tools, E6.3-1/4" drive with 4 mm hexagon to accommodate SAC bits

---

## SAC BIT M12-D15 - Tool

1208432

<https://www.phoenixcontact.com/in/products/1208432>



Nut for assembling sensor/actuator cables with M12 connector and M12 connectors for assembly, with a knurl diameter of 15 mm, for 4 mm hexagonal drive

---

Phoenix Contact 2024 © - all rights reserved  
<https://www.phoenixcontact.com>

PHOENIX CONTACT (I) Pvt. Ltd.  
A-58/2, Okhla Industrial Area, Phase - II, New Delhi-110 020

+91.1275.71420  
[info@phoenixcontact.co.in](mailto:info@phoenixcontact.co.in)